

PANEL CUTOUT
FRONT SIDE MOUNTING

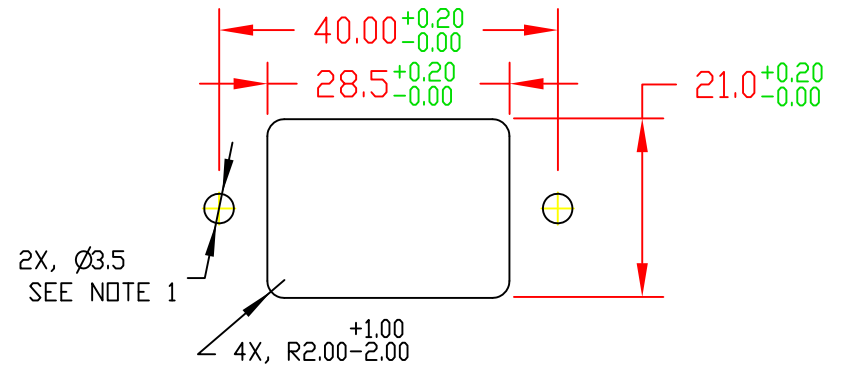

PANEL CUTOUT
REAR SIDE MOUNTING

NOTE 1: RECOMMENDED DIAMETER FOR THRU-HOLE (SCREW/NUT COMBINATION) HARDWARE MOUNTING METHOD. OTHER METHODS WILL REQUIRE HOLES WITH DIFFERENT DIMENSIONS AND PARAMETERS.

THIS DOCUMENT AND ITS CONTENTS ARE THE PROPRIETARY CONFIDENTIAL PROPERTY OF INTERPOWER CORPORATION. NO USE OR COPIES MAY BE MADE WITHOUT WRITTEN PERMISSION FROM INTERPOWER CORPORATION.

DIMENSIONS IN MILLIMETERS

TITLE: C18 Screw Mount Inlet with 6.3mm QD's

DRAFT BY: DDF DATE: 07/20/16

PART NUMBER: 83030300

DRAFTING APPROVAL: JPC DATE: 07/21/16

MATERIAL:

DD NOT SCALE

INTERPOWER CORPORATION

DATE

SHEET 1 OF 1

REV	CHANGE DESCRIPTION	DATE	INITIALS
B	Added N.American ratings to face view.	10/11/16	DDF
A	Introduction of Interpower Corporation manufactured part.	07/20/16	DDF