

Back

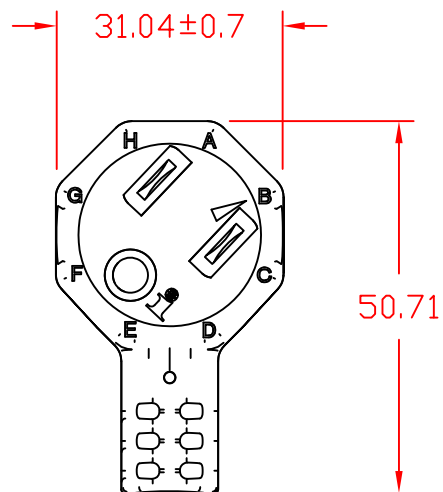

Front

Angle B

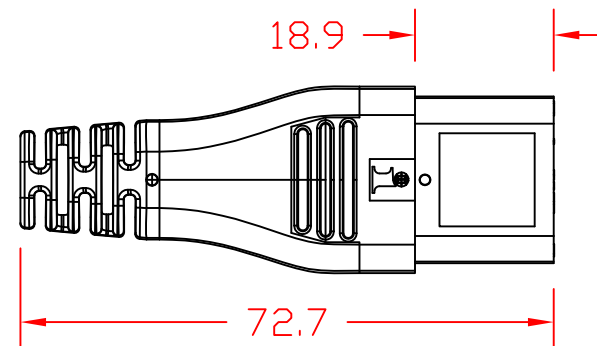

THIS DOCUMENT AND ITS CONTENTS ARE THE PROPRIETARY CONFIDENTIAL PROPERTY OF INTERPOWER CORPORATION. NO USE OR COPIES MAY BE MADE WITHOUT WRITTEN PERMISSION FROM INTERPOWER CORPORATION.

REV	CHANGE DESCRIPTION	DATE	INITIALS
D	Removed all non-technical markings.	3/15/18	DDF
C	Updated C13 length dimension from 71.4mm to 72.7mm.	9/12/13	DDF
B	Fixed orientation of pins in top drawing	09/28/11	ATS/KKA
A	Replaced 002 C13 with new C13 052	12/04/07	

DIMENSIONS IN MILLIMETERS		TITLE	Angled NEMA 5-15P 8ft
DRAFT BY:	JPC	DATE:	2-16-2004
DRAFTING APPROVAL:	JPC	DATE:	2-16-2004
MATERIAL:		PART NUMBER:	86420150
		DO NOT SCALE	INTERPOWER CORPORATION
		SHEET 1 OF 1	