

BACK

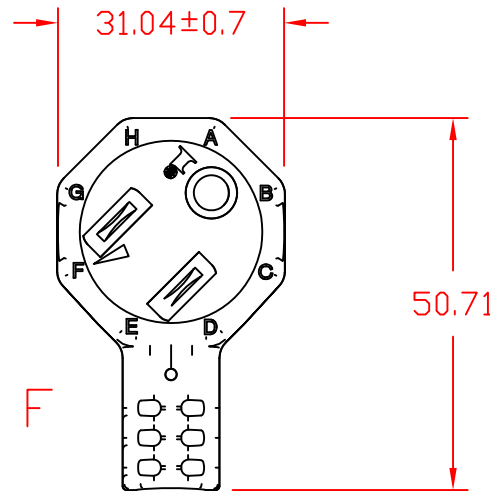

Angle F

Front

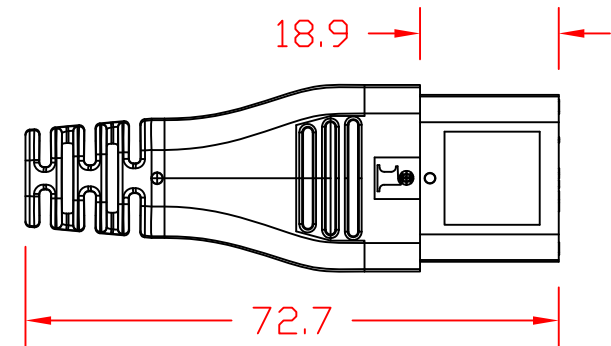

THIS DOCUMENT AND ITS CONTENTS ARE THE PROPRIETARY CONFIDENTIAL PROPERTY OF INTERPOWER CORPORATION. NO USE OR COPIES MAY BE MADE WITHOUT WRITTEN PERMISSION FROM INTERPOWER CORPORATION.

DIMENSIONS IN MILLIMETERS

TITLE Angled NEMA 5-15P
8ft

DRAFT BY: JPC DATE: 2-16-2004

PART NUMBER: 86460105

DRAFTING APPROVAL: JPC DATE: 2-16-2004

MATERIAL:

DD NOT SCALE

INTERPOWER CORPORATION

SHEET 1 OF 1

REV	CHANGE DESCRIPTION	DATE	INITIALS
C	Removed all non-technical markings.	3/28/18	DDF
B	Updated C13 length dimension from 71.4mm to 72.7mm	9/18/13	ATS/JDD
A	Replaced 002 C13 with new C13 052	12/04/07	