

Back

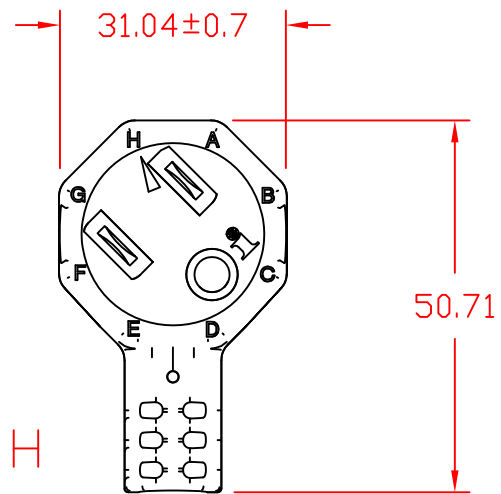

Front

Angle H

THIS DOCUMENT AND ITS CONTENTS ARE THE PROPRIETARY CONFIDENTIAL PROPERTY OF INTERPOWER CORPORATION. NO USE OR COPIES MAY BE MADE WITHOUT WRITTEN PERMISSION FROM INTERPOWER CORPORATION.

DIMENSIONS IN MILLIMETERS

TITLE Angled NEMA 5-15P
6ft

DRAFT BY: JPC DATE: 2-16-2004

PART NUMBER: 86480000

DRAFTING APPROVAL: JPC DATE: 2-16-2004

MATERIAL:

DD NOT SCALE

INTERPOWER CORPORATION

A Removed all non-technical markings.

5/1/18 DDF

REV CHANGE DESCRIPTION

DATE INITIALS

SHEET 1 OF 1