

Back

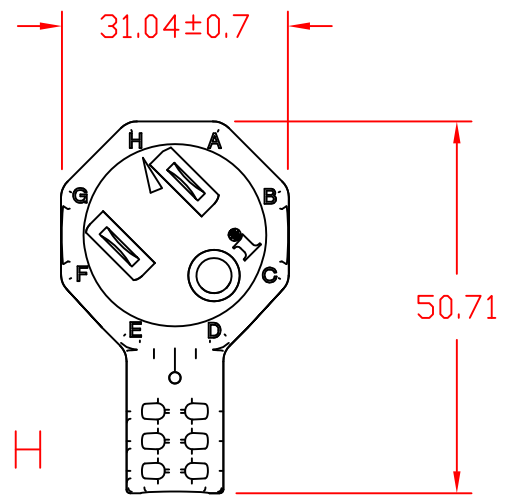

Front

Angle H

THIS DOCUMENT AND ITS CONTENTS ARE THE PROPRIETARY CONFIDENTIAL PROPERTY OF INTERPOWER CORPORATION. NO USE OR COPIES MAY BE MADE WITHOUT WRITTEN PERMISSION FROM INTERPOWER CORPORATION.

DIMENSIONS IN MILLIMETERS

TITLE Angled NEMA 5-15P
10ft

DRAFT BY: JPC DATE: 2-16-2004

PART NUMBER: 86480055

DRAFTING APPROVAL: JPC DATE: 2-16-2004

MATERIAL:

DD NOT SCALE

INTERPOWER CORPORATION

REV	CHANGE DESCRIPTION	DATE	INITIALS
A	Removed all non-technical markings.	5/1/18	DDF

SHEET 1 OF 1