

FACE

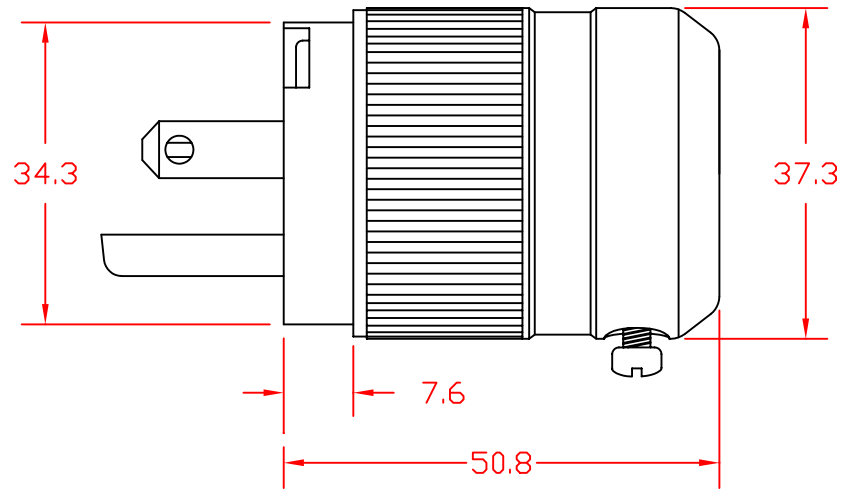

SIDE VIEW

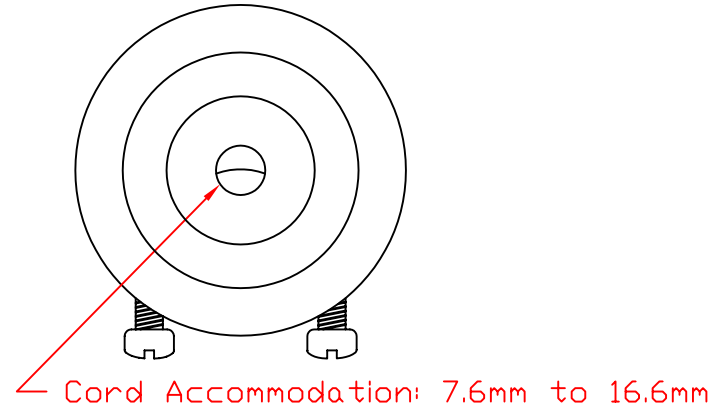

BACK

THIS DOCUMENT AND ITS CONTENTS ARE THE PROPRIETARY CONFIDENTIAL PROPERTY OF INTERPOWER CORPORATION. NO USE OR COPIES MAY BE MADE WITHOUT WRITTEN PERMISSION FROM INTERPOWER CORPORATION.

DIMENSIONS IN MILLIMETERS

TITLE NEMA 6-20P

DRAFT BY: JPC

DATE: 5-5-2003

PART NUMBER:

88030180

MATERIAL:

DO NOT SCALE

INTERPOWER CORPORATION

SHEET 1 OF 1

| REV | CHANGE DESCRIPTION | DATE | INITIALS |
|-----|--------------------|------|----------|
| | | | |
| | | | |
| | | | |