

88261100 & 88262100  
QUICK DISCONNECT CONTACTS

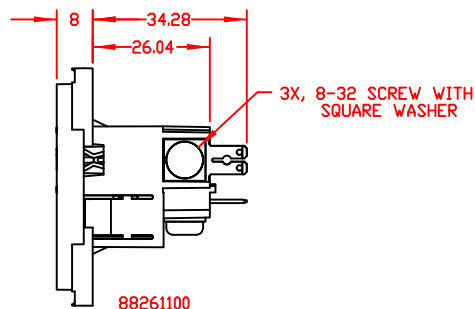

88261100

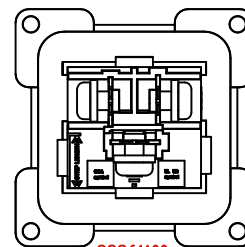

88261100

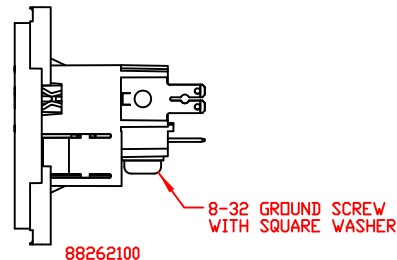

88262100

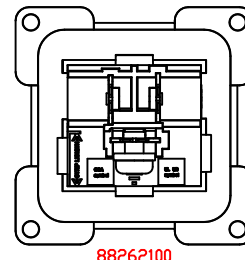

88262100

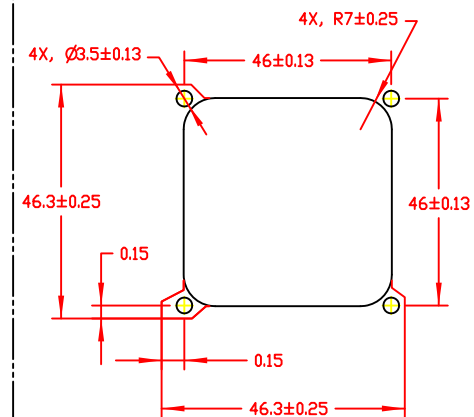

THIS PANEL CUTOUT IS RECOMMENDED WHEN USED IN COMBINATION WITH THE 88052XXX FAMILY OF SOCKETS

NOTES:  
1. RECOMMENDED DIAMETER FOR THRU-HOLE (SCREW/NUT COMBINATION) HARDWARE MOUNTING METHOD. OTHER METHODS WILL REQUIRE HOLES WITH DIFFERENT DIMENSIONS AND PARAMETERS.

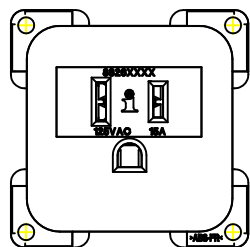

88263100 & 88264100  
SOLDER TAB CONTACTS

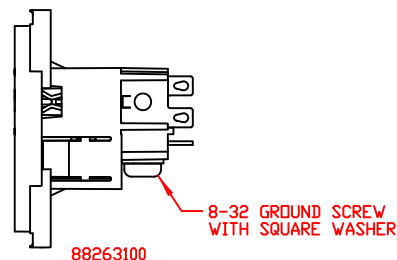

88263100

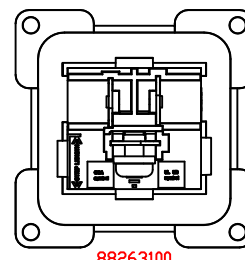

88263100

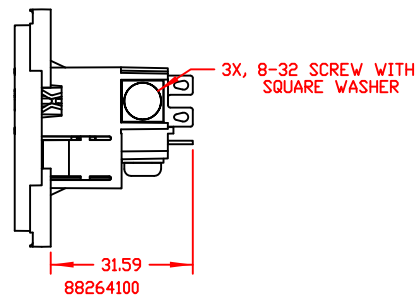

88264100

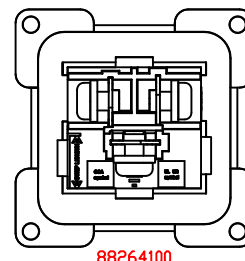

88264100

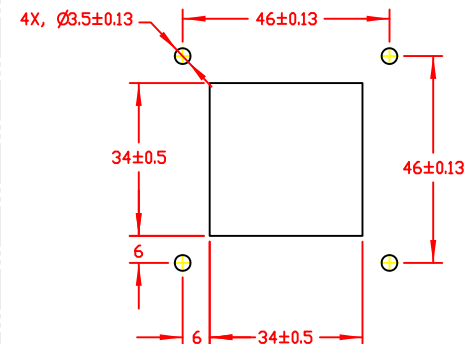

THIS PANEL CUTOUT IS RECOMMENDED FOR ALL OTHER APPLICATIONS

THIS DOCUMENT AND ITS CONTENTS ARE THE PROPRIETARY, CONFIDENTIAL PROPERTY OF INTERPOWER CORPORATION. NO USE OR COPIES MAY BE MADE WITHOUT WRITTEN PERMISSION FROM INTERPOWER.

DIMENSIONS IN: MM

TITLE BLACK NEMA 5-15 SCREW  
MOUNT ASSEMBLIES

DRAFT BY: BEM DATE: 9-30-13

PART NUMBER: 88261100, 88262100  
88263100, 88264100

DRAFTING APPROVAL: SRK DATE: 9-30-13

MATERIAL:

DO NOT SCALE

SHEET 1 OF 1

INTERPOWER CORPORATION

REV	DATE	DESCRIPTION	DATE	BY
1	2	INITIAL RELEASE	10/07/13	DDF
2D	3D	CHANGE DESCRIPTION		
REV				