

Back

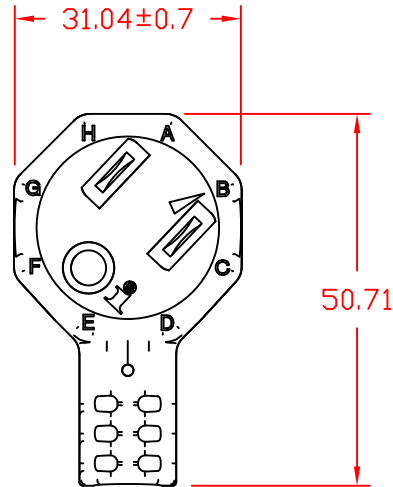

Front

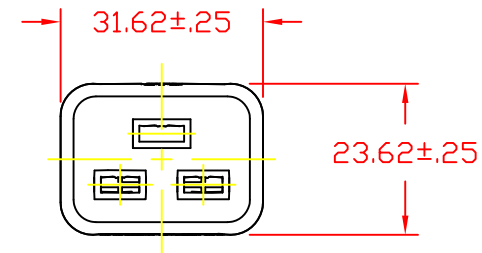

Angle B

THIS DOCUMENT AND ITS CONTENTS ARE THE PROPRIETARY CONFIDENTIAL PROPERTY OF INTERPOWER CORPORATION. NO USE OR COPIES MAY BE MADE WITHOUT WRITTEN PERMISSION FROM INTERPOWER CORPORATION.

DIMENSIONS IN MILLIMETERS

TITLE: Angled NEMA 5-15P
6 FT

DRAFT BY: JPC DATE: 2-16-2004

PART NUMBER: 86420615

DRAFTING APPROVAL: DDF DATE: 10-9-2012

MATERIAL: PVC

DO NOT SCALE

INTERPOWER CORPORATION

SHEET 1 OF 1

REV	CHANGE DESCRIPTION	DATE	INITIALS
C	Removed all non-technical markings.	3-16-18	DDF
B	CHANGED FROM 011 C19 CONNECTOR TO 068 C19 CONNECTOR	10-5-12	ATS-JDD
A	Fixed orientation of pins in top drawing	09/28/11	ATS/KKA