

Back

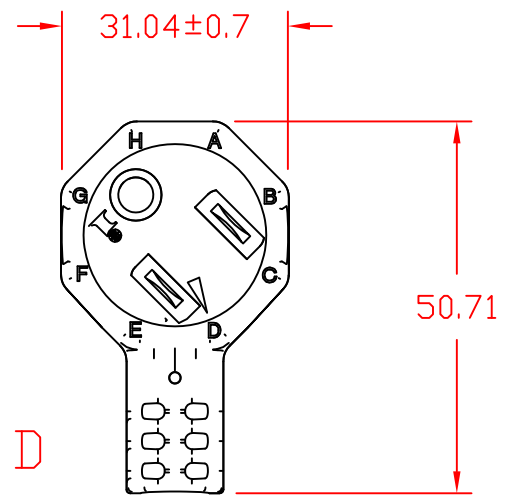

Front

Angle D

THIS DOCUMENT AND ITS CONTENTS ARE THE PROPRIETARY CONFIDENTIAL PROPERTY OF INTERPOWER CORPORATION. NO USE OR COPIES MAY BE MADE WITHOUT WRITTEN PERMISSION FROM INTERPOWER CORPORATION.

DRAFT BY: JPC		DATE: 2-16-2004		TITLE: Angled NEMA 5-15P 8ft	
DRAFTING APPROVAL: JPC		DATE: 2-16-2004		PART NUMBER: 86440035	
MATERIAL:				DD NOT SCALE	
				SHEET 1 OF 1	
INTERPOWER CORPORATION					

REV	CHANGE DESCRIPTION	DATE	INITIALS
A	Removed all non-technical markings.	3/22/18	DDF