

Back

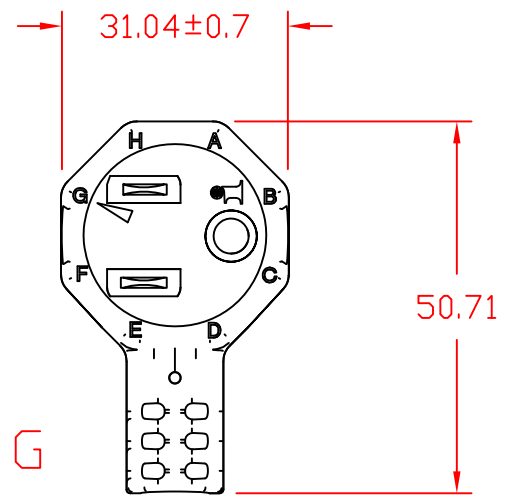

Front

Angle G

THIS DOCUMENT AND ITS CONTENTS ARE THE PROPRIETARY CONFIDENTIAL PROPERTY OF INTERPOWER CORPORATION. NO USE OR COPIES MAY BE MADE WITHOUT WRITTEN PERMISSION FROM INTERPOWER CORPORATION.

DIMENSIONS IN MILLIMETERS				TITLE Angled NEMA 5-15P 6ft	
DRAFT BY: JPC		DATE: 2-16-2004		PART NUMBER: 86470015	
DRAFTING APPROVAL: JPC		DATE: 2-16-2004		INTERPOWER CORPORATION	
MATERIAL:				DD NOT SCALE	
				SHEET 1 OF 1	

REV	CHANGE DESCRIPTION	DATE	INITIALS
A	Removed all non-technical markings.	4/4/18	DDF